

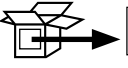











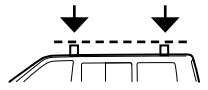

Cruzber S.A., ES-A14018311
P.I. Las Salinas II, E-14960 Rute
www.cruzber.com





- (E)** Instrucción de montaje
¡Leer primero!
- (GB)** Assembly instructions
Read first!
- (F)** Instruction de montage
Lire en premier!
- (D)** Montageanleitung
Zuerst lesen!
- (PT)** Instruções de montagem
Ler primeiro!
- (PL)** Instrukcja montażu
Najpierw przeczytaj!
- (CZ)** Montážní návod
Čtěte pozorně!
- (HU)** Szerelési Utasítás
Először olvassd el!
- (RO)** Instrucțiuni de montaj
Întai citiți!
- (HR)** Detaljne upute
Prvo pročitati!
- (GR)** Διαβάστε προσεκτικά τις
Οδηγίες Συναρμολόγησης!
- (TR)** Öncelikli montaj:
Talimatlarını okuyunuz!
- (RU)** Инструкции по монтажу
Сначала прочитайте!
- (IT)** Istruzioni di montaggio
Leggere per primo!
- (NL)** Montagehandleiding
Eerst lezen!
- (SLO)** Navodila za sestavljanje
Preberite!

- Barras de acero
- Steel bars
- Barres d'acier
- Stahldachträger
- Barras d'aço
- Belki stalowe
- Ocelové střešní nosiče
- Acél rudak
- Čelične šipke
- Bare din otel
- Μπάρες Σιδερέ
- Çelik barlar
- Стальные поперечины
- Barre d'acciaio
- Stalen dakdragers
- Jeklene prečke

Código Code Code Code	922-432		
	Lv 7 2013 - r 12		
Modelo Model Modèle Modell	30x20x1,5		
Lote Lot Lot Lot	03 -11	Peso Weight Poids Gewicht	7,16 kg
  			
 		Max: 150 kg	
			
Código Homologación CEE EEC Type Approval Number e9*74/483*2007/15*3024			

	1°		
	2°		
			

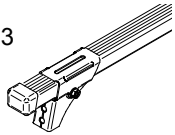
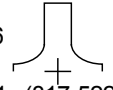
- (E)** Contenido embalaje: ¡Verificar!
- (GB)** Package content: Check!
- (F)** Contenu d'emballage: Vérifier!
- (D)** Packungsinhalt: Überprüfen!
- (PT)** Contéudo embalagem: Verificar!
- (PL)** Zawartość opakowania: sprawdzić!
- (CZ)** Obsah balení: Zkontrolujte!
- (HU)** Csomag tartalma: Ellenőrizd!
- (RO)** Pachetul contine: Verificati!
- (HR)** Sadržaj paketa: Provjeri!
- (GR)** Ελέγξτε το περιεχόμενο: του πακέτου!
- (TR)** Paket içeriğini: Control ediniz!
- (RU)** Содержание упаковки: Проверьте!
- (IT)** Contenuto della confezione: Controllare!
- (NL)** Pakket inhoud: Controleer!
- (SLO)** Vsebina paketa: Preverite!

x 1 	x 1 	x 3  (823-323) 120 cm	x 6  1x (817-522) 1x (817-523) 2x (817-524) 1x (817-525) 1x (817-526)
x 6  (813-062)	x 2  1x (805-027) 1x (810-034)		

Código
Code
Code
Kode

922-432

Lv7 2013-r12

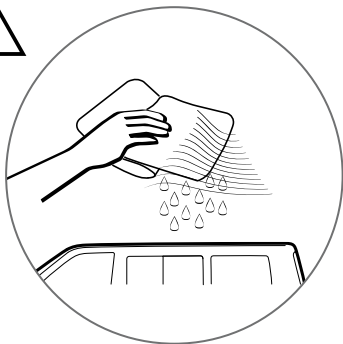

1

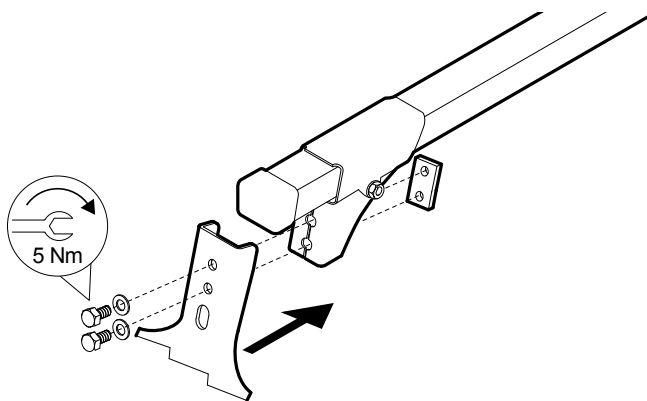

2

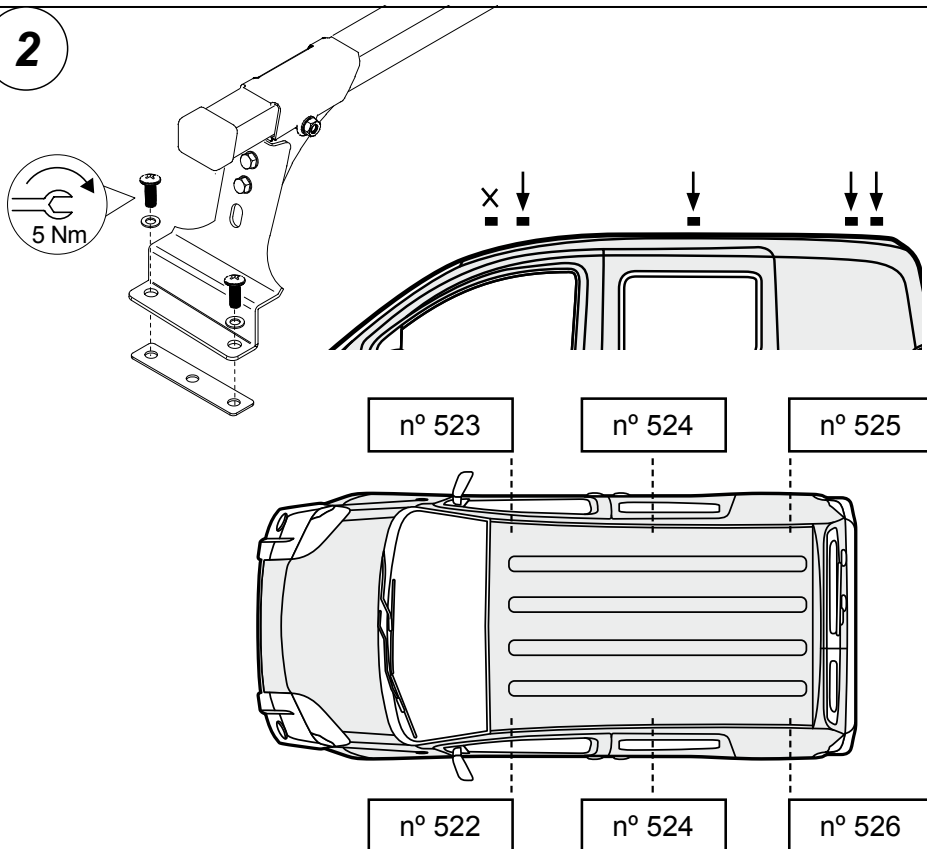

3

