

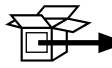











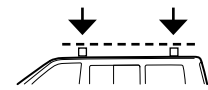

Cruzber S.A., ES-A14018311
P.I. Las Salinas II, E-14960 Rute
www.cruzber.com







- (E)** Instrucción de montaje
¡Leer primero!
- (GB)** Assembly instructions
Read first!
- (F)** Instruction de montage
Lire en premier!
- (D)** Montageanleitung
Zuerst lesen!
- (PT)** Instruções de montagem
Ler primeiro!
- (PL)** Instrukcja montażu
Najpierw przeczytaj!
- (CZ)** Montážní návod
Čtěte pozorně!
- (HU)** Szerelési Utasítás
Először olvasd el!
- (RO)** Instrucțiuni de montaj
Întai citiți!
- (HR)** Detaljne upute
Prvo pročitati!
- (GR)** Διαβάστε προσεκτικά τις
Οδηγίες Συναρμολόγησης!
- (TR)** Öncelikli montaj:
Talimatlarını okuyunuz!
- (RU)** Инструкции по монтажу
Сначала прочитайте!
- (IT)** Istruzioni di montaggio
Leggere per primo!
- (NL)** Montagehandleiding
Eerst lezen!
- (SLO)** Navodila za sestavljanje
Preberite!

- Barras de aluminio
- Aluminium bars
- Barres d'aluminium
- Aluminiumdachträger
- Barras d'alumínio
- Belki aluminiowe
- Hliníková sada tyčí
- Aluminium rudak
- Aluminijske šipke
- Bare din aluminiu
- Μπάρες Αλουμινίου
- Alüminyum barlar
- Алюминиевые поперечины
- Barre di alluminio
- Aluminium dakdragers
- Aluminijske prečke

Código Code Code Kode	924-311		
	Lv 7 2013 - r8		
Modelo Model Modèle Modell	Alu-Cargo		
Lote Lot Lot Lot	07 -11	Peso Weight Poids Gewicht	4,45 kg
  			
 		Max: 100 kg	
			
Código Homologación CEE EEC Type Approval Number e9*74/483*2007/15*3024			

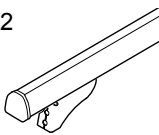
	1°		
	2°		
			

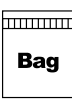
- (E)** Contenido embalaje: ¡Verificar!
- (GB)** Package content: Check!
- (F)** Contenu d'emballage: Vérifier!
- (D)** Packungsinhalt: Überprüfen!
- (PT)** Contéudo embalagem: Verificar!
- (PL)** Zawartość opakowania: sprawdzić!
- (CZ)** Obsah balení: Zkontrolujte!
- (HU)** Csomag tartalma: Ellenőrizd!
- (RO)** Pachetul contine: Verificati!
- (HR)** Sadržaj paketa: Provjeri!
- (GR)** Ελέγξτε το περιεχόμενο: του πακέτου!
- (TR)** Paket içeriğini: Control ediniz!
- (RU)** Содержание упаковки: Проверьте!
- (IT)** Contenuto della confezione: Controllare!
- (NL)** Pakket inhoud: Controleer!
- (SLO)** Vsebina paketa: Preverite!

x 1 	x 1 	x 2  (824-010) 118 cm	x 4  2x (012-029) 2x (012-056)
x 2  1x (810-011) 1x (805-015)	x 4  (817-507)	x 4  (813-061)	

Código
Code
Code
Kode

924-311

Lv 7 2013 - r8

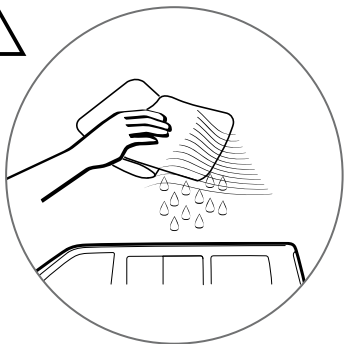

1

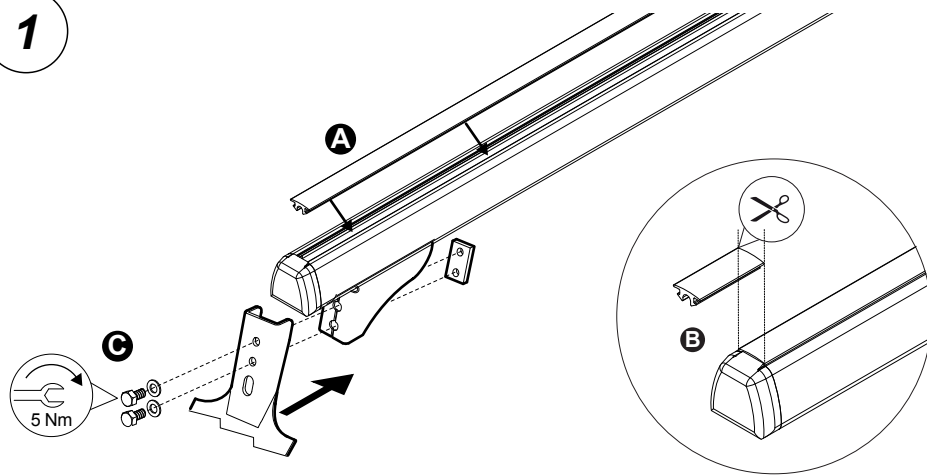

2

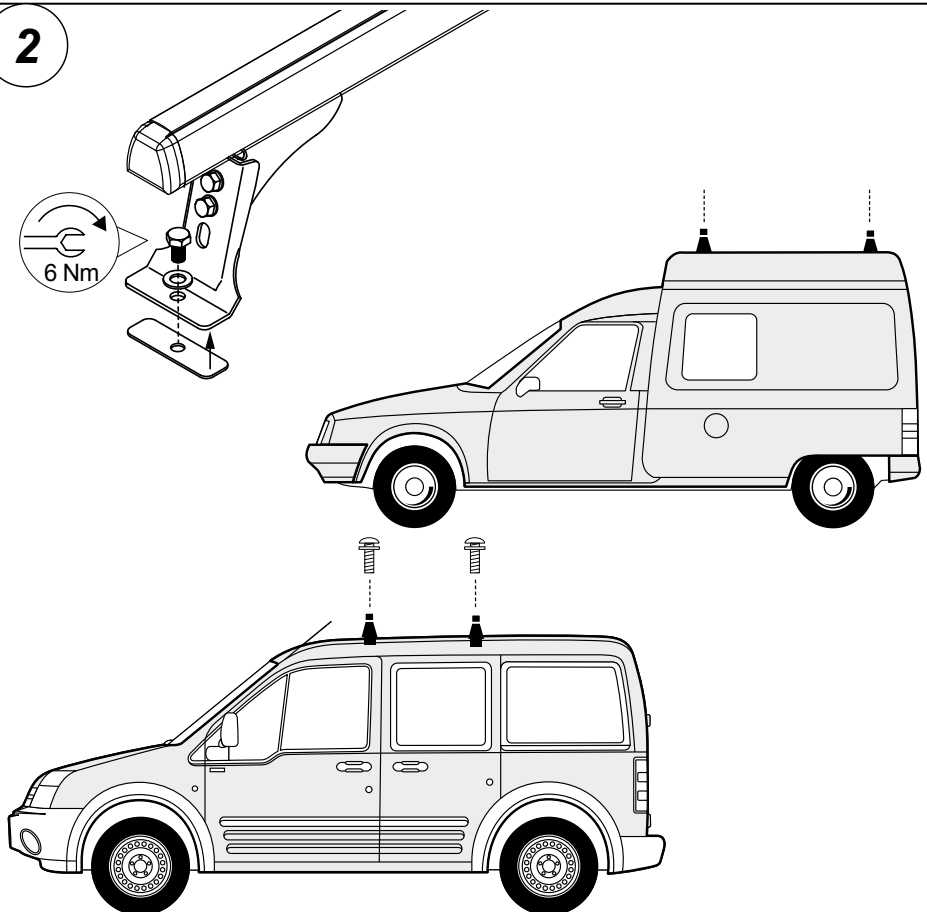

3

