

MISUTONIDA
italian style accessories **4x4**

NISSAN QASHQAI 2010



Item Code

: **DSP/265/IX**

Codice Articolo

GPO/265/IX

Référence Article

GB

STAINLESS STEEL
GRAND PEDANA

ITA

















GRAND PEDANA
IN ACCIAIO INOX

FR

GRAND PEDANA
EN ACCIER INOX

NISSAN QASHQAI 2010

Part List
 Lista della bulloneria
 Liste des pièces

A  TE 8X20 x 8	B  Ø 8 x 12	C  Ø 8 x 12	D  M 8 x 10	E  TPS/163/B x 2
F  TE 8X30 x 2	G  GP/265/C x 2	H  Ø 6 Big Grandi Grand x 4	I  Ø 6 x 4	L  M 6 x 2
M  GP/265/D x 2	N  Ø 10 x 2	O  Ø 10 x 2	P  M 10 x 2	Q  GPO/265/A x 2
R  GPO/265/B x 2				

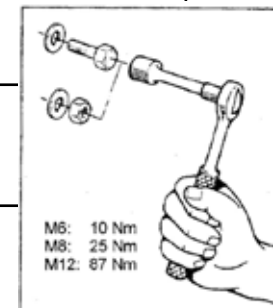

 **MISUTONIDA**
  *italian style* **4x4**
 accessories

NISSAN QASHQAI 2010

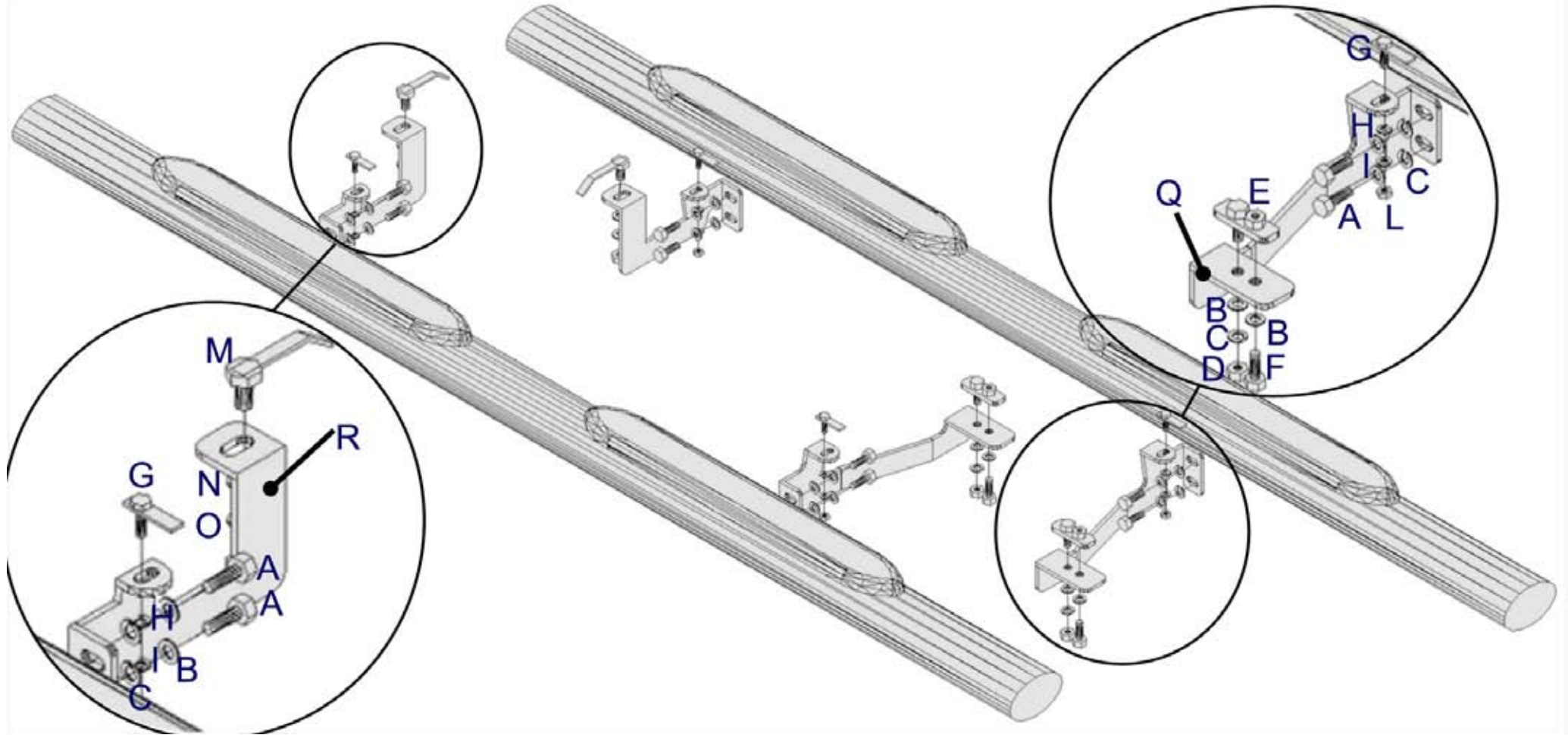

FRONT SIDE

PARTE ANTERIORE

PARTIE ANTERIEURE

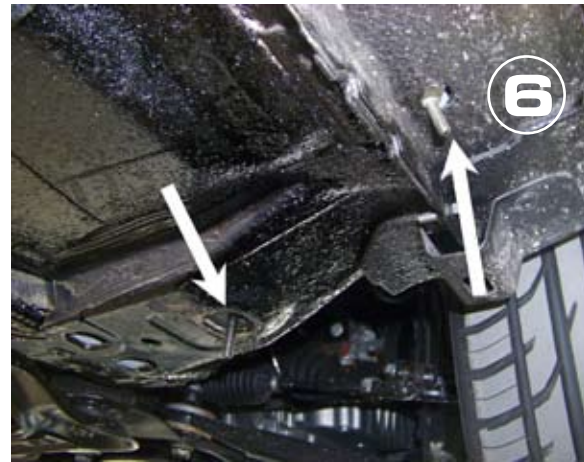
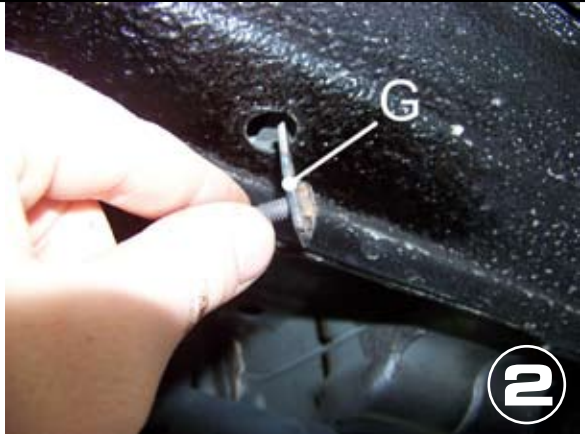
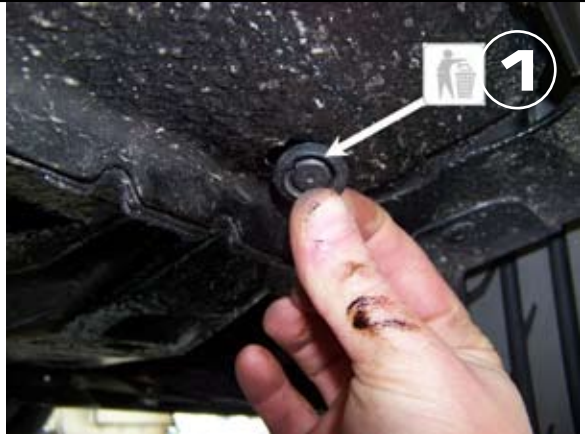

 **MISUTONIDA**
  *italian style* **4x4**
accessories

REAR SIDE

PARTE POSTERIORE

PARTIE POSTERIEURE

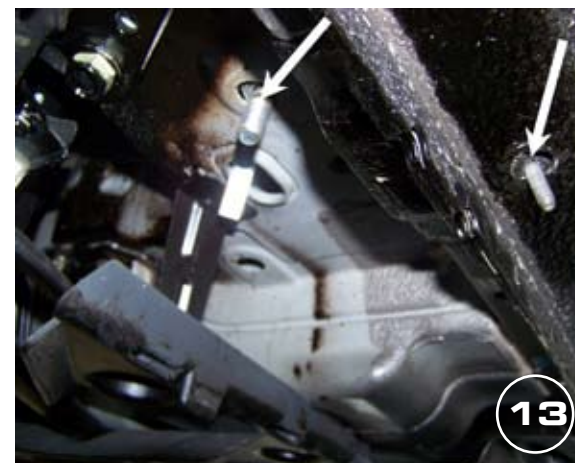
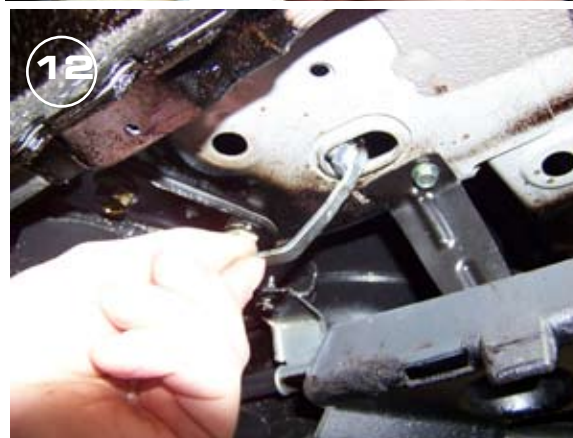
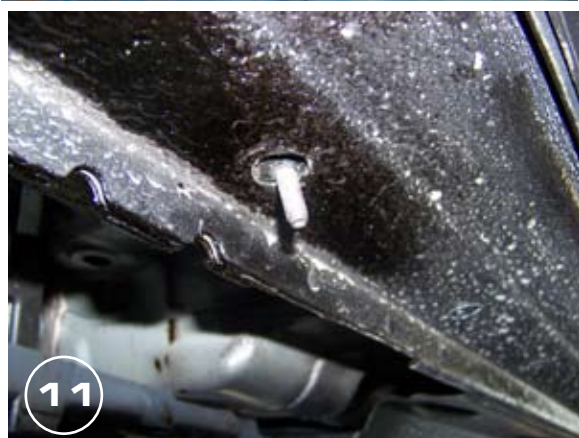
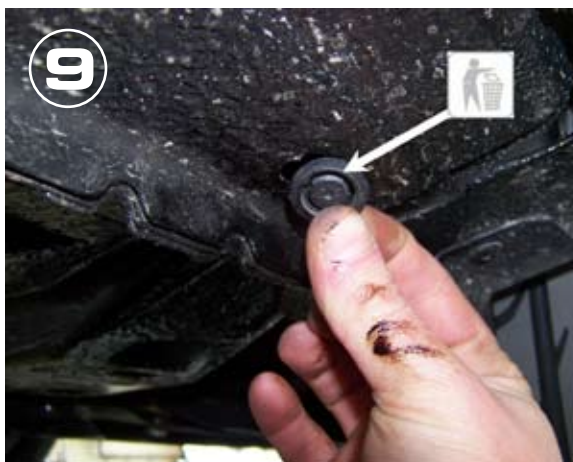

Date Data Date	Item Code Cod.Articolo Réf. Article	Vehicle model Modello Veicolo Modèle de Voiture
05/05/10	GPO/265/IX DSP/265/IX	N I S S A N QASHQAI

REAR SIDE

PARTE POSTERIORE

PARTIE POSTERIEURE

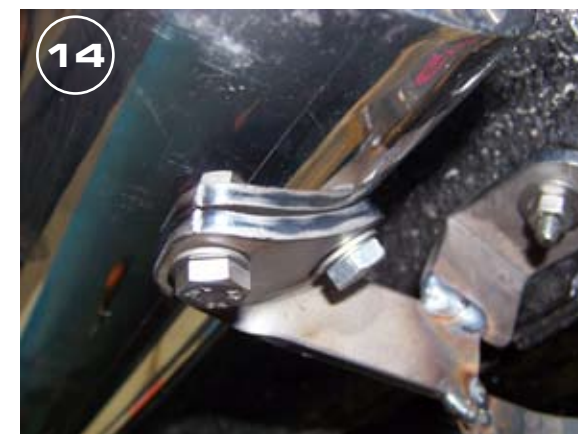

 **MISUTONIDA**
italian style accessories **4x4**



Date Data Date	Item Code Cod.Articolo Réf. Article	Vehicle model Modello Veicolo Modèle de Voiture
05/05/10	GPO/265/IX DSP/265/IX	NISSAN QASHQAI

Document checked and approved by
Documento controllato ed approvato da
Document contrôlé et approuvé par

**Botta
Pietro**