

 **MISUTONIDA**
italian style **4x4**
accessories

FORD KUGA



Item Code

Codice Articolo

: P/223/IX

Référence Article

GB

**STAINLESS STEEL
SIDE STEPS**











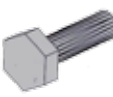





ITA

**PEDANA
IN ACCIAIO INOX**

FR

**MARCHEPIED
EN ACCIER INOX**

FORD KUGA

Part List		Lista della bulloneria		Liste des pièces	
A	TE 10X50 x 4	L	Ø 6 x 2		
B	M10 autoblocking autobloccante autobloquant x 4	M	M6 x 2		
C	P/152/A x 2	N	P/223/P2 x 2		
D	P/223/A x 2	O	TE 10x30 x 2		
E	Ø 8 x 4	P	Ø 10 x 2		
F	Ø 8 x 4	Q	Ø 10 x 2		
G	M8 x 4	R	S/223/A x 2		
H	P/223/A x 2	S	S/222/P x 2		
I	Ø 6 x 2				

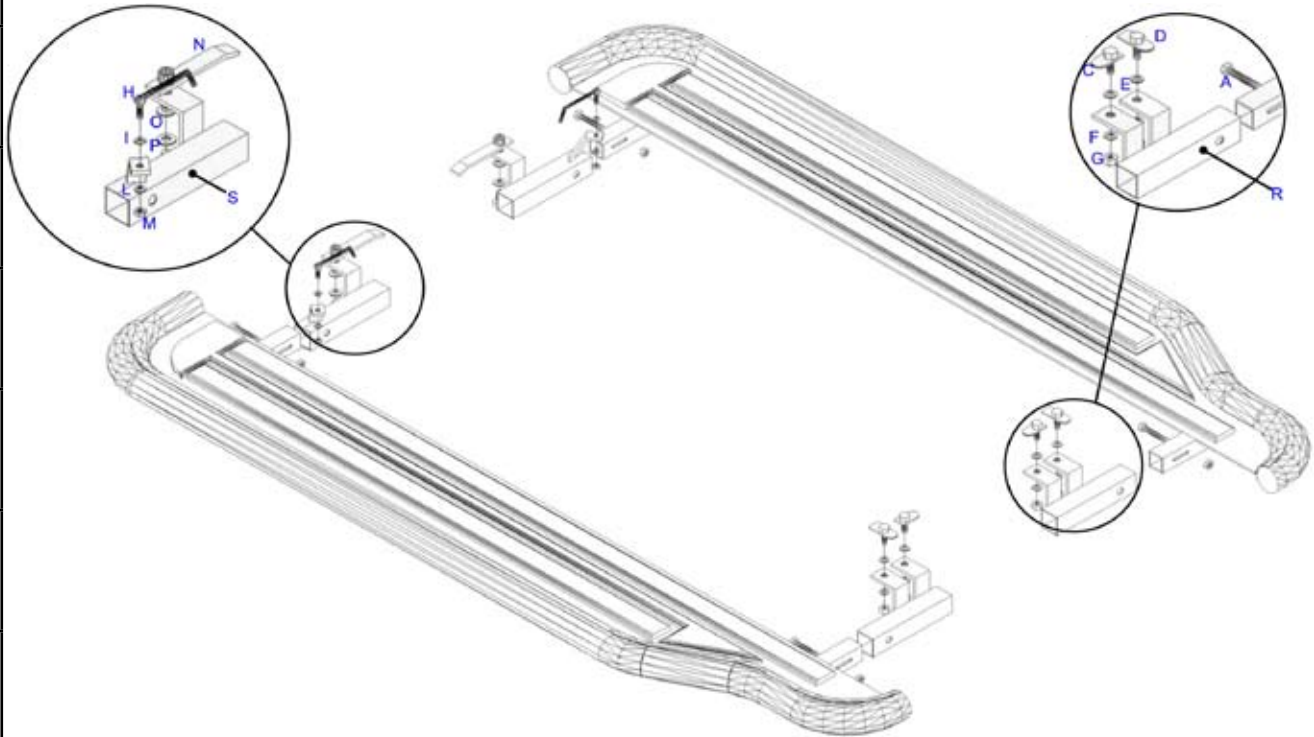

GB**FITTING
INSTRUCTIONS****FRONT SIDE**

1. Insert C and D (two per side) in the holes shown in picture 1 and 2.
2. Fit R on C and D using E,F,G as shown in picture 3.

REAR SIDE

3. Remove the 2 caps indicated in picture 4 and insert H as shown in picture 5.
4. Insert N as shown in picture 6.
5. Fit S on N and H as shown in picture 7 using I,L,M and O,P,Q as shown in pictures 8 and 9.
6. Tighten all the set of bolts.

ITA**ISTRUZIONI DI
MONTAGGIO****PARTE ANTERIORE**

1. Inserire C e D (due per lato) nei fori indicati in foto 1 e 2.
2. Montare i supporti R su C e D utilizzando E,F,G come indicato in foto 3.

PARTE POSTERIORE

3. Rimuovere i 2 tappi indicati in foto 4 e inserire H come indicato in foto 5.
4. Inserire N come indicato in foto 6.
5. Montare i supporti S su N e H come indicato in foto 7 utilizzando I,L,M e O,P,Q come indicato in foto 8 e 9.
6. Serrare tutta la bulloneria.

FR**INSTRUCTIONS DE
MONTAGE****PARTIE ANTERIEURE**

1. Insérer C et D (2 pour côté) dans les trous indiqués en photos 1 et 2.
2. Monter les supports R sûr C et D en utilisant E,F,G comme indiqué dans la photo 3.

PARTIE POSTERIEURE

3. Enlever les 2 bouchons indiqués en photo 4 et insérer H comme indiqué dans la photo 5.
4. Insérer N comme indiqué dans la photo 6.
5. Monter S sûr N et H comme indiqué dans la photo 7 en utilisant I,L,M et O,P,Q comme indiqué dans les photos 8 et 9.
6. Serrer toute la boulonnerie.





Date Data Date	Item Code Cod.Articolo Réf. Article	Vehicle model Modello Veicolo Modèle de Voiture
26/06/08	P/223/IX	FORD KUGA

Checked and approved by
Controllato ed approvato da
 Controlé et approuvé par

**Claudio
 Gallo**

MISUTONIDA
 italian style accessories **4x4**