

MISUTONIDA

  *italian style* **4x4**
accessories



90 Min.

GB

STAINLESS STEEL ROLL BAR ON
TONNEAU 2 PIPES







ITA

ROLL BAR SPONDE IN ACCIAIO
INOX 2 TUBI

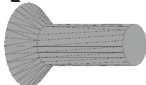
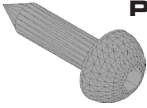
FR

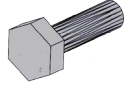
ROLL BAR SUR LE BORD DE LA
BENNE EN ACCIER INOX 2 TUBES

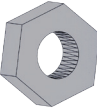
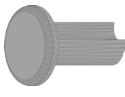
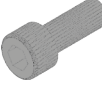
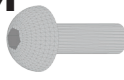
Part List
 Lista della bulloneria
 Liste des pièces

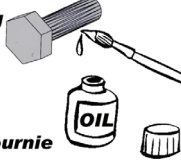
A  TSPEI M10X25 x 4	B  PARKER M6.2X25 x 4	C  Plastic Ø 6 Plastica Plastique x 4	D  VIPLA Ø80 Plastic Plastica Plastique x 4	E  TE M8X20 x 4
F  Ø 8 x 8	G  Ø 8 x 8	H  M8 x 4	I  Plastic Plastica Plastique x 6	L  T C E I M10X25 x 4
M  T B C E I M8X25 x 4	N  MIT bracket Staffe MIT Etriers MIT x4	O RLB Ø76 x 2	P  Strip rubber Striscia in gomma Caoutchouc de bande x4	Cappelletti M8 x 10
<p><i>lubricate the set of bolts supplied before tightening them</i></p>			<p><i>Si consiglia di lubrificare la bulloneria in dotazione prima del settaggio</i></p> 	
<p><i>Lubrifier la boulonnerie fournie avat de la serrer</i></p>				

MISUTONIDA
 italian style
 accessories **4x4**

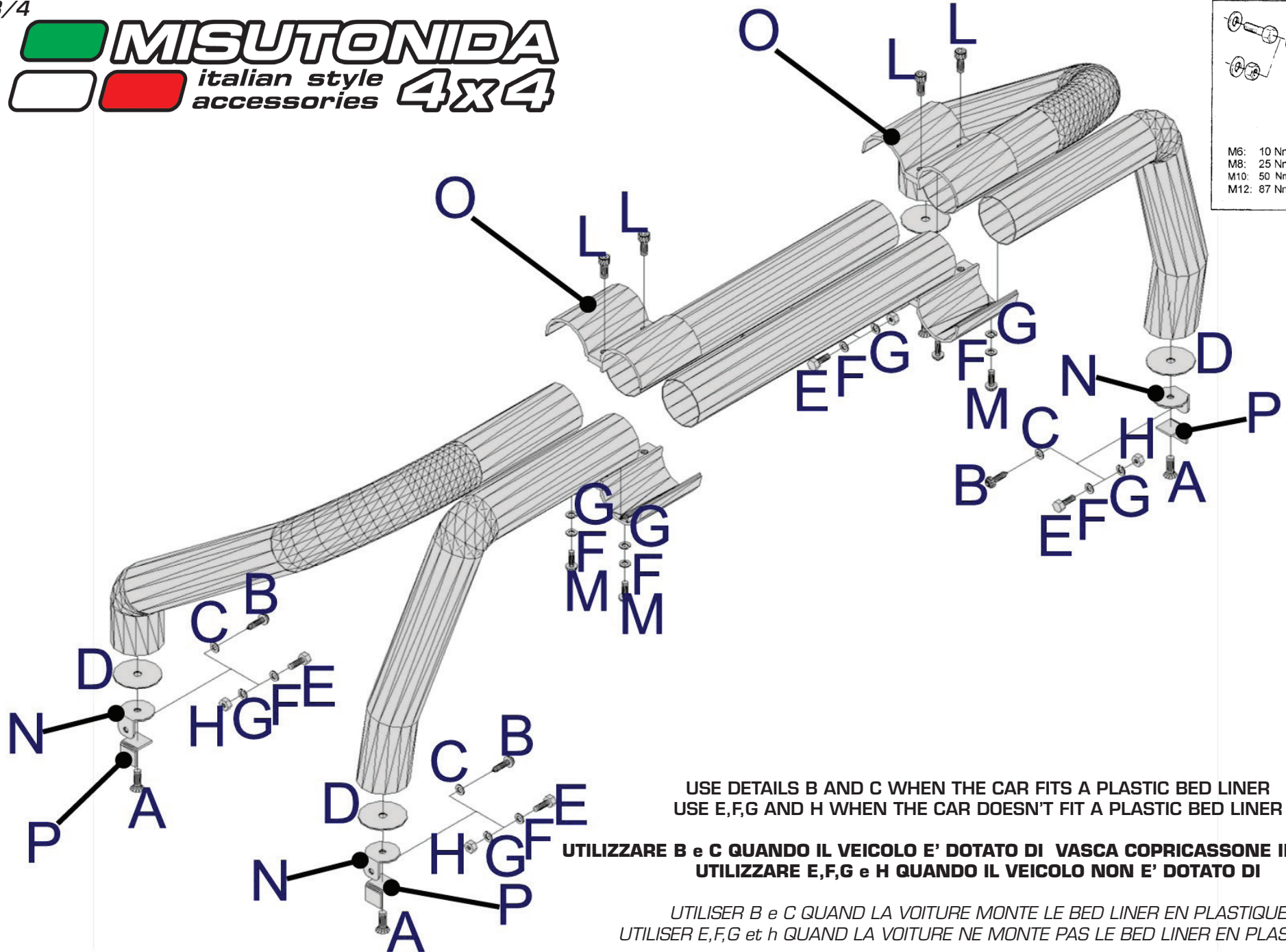

PART NUMBER	VEHICLE MODEL
RLD/400/1X	NISSAN NP 300 NAVARA 2016
RLD/295/1X	FORD RANGER 2016

