

**MISUTONIDA**  
*italian style accessories* **4x4**

**FORD RANGER D.C. 2012**



Item Code

Codice Articolo

Référence Article

**GP/295/IX**

**GB**

STAINLESS STEEL  
GRAND PEDANA

**ITA**









GRAND PEDANA  
IN ACCIAIO INOX

**FR**

GRAND PEDANA  
EN ACCIER INOX

# FORD RANGER D.C. 2012

Part List  
 Lista della bulloneria  
 Liste des pièces

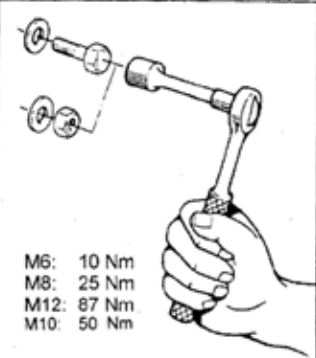
<b>A</b>  <b>TE 8X20</b> <b>x 8</b>	<b>B</b>  <b>Ø 8</b> <b>x8</b>	<b>C</b>  <b>Ø 8</b> <b>x 8</b>	<b>D</b>  <b>TE 10X20</b> <b>x 8</b>	<b>E</b>  <b>Ø 10</b> <b>x 8</b>
<b>F</b>  <b>Ø 10</b> <b>x 8</b>	<b>G</b>  <b>GP/295/A</b> <b>x 2</b>	<b>H</b>  <b>GP/295/B</b> <b>x 2</b>	<b>I</b>  <b>Cappelletti M8</b> <b>x 8</b>	
				 <p>           M6: 10 Nm            M8: 25 Nm            M12: 87 Nm            M10: 50 Nm         </p>

 **MISUTONIDA**  
 **italian style  
accessories 4x4**

# ***FORD RANGER D.C. 2012***

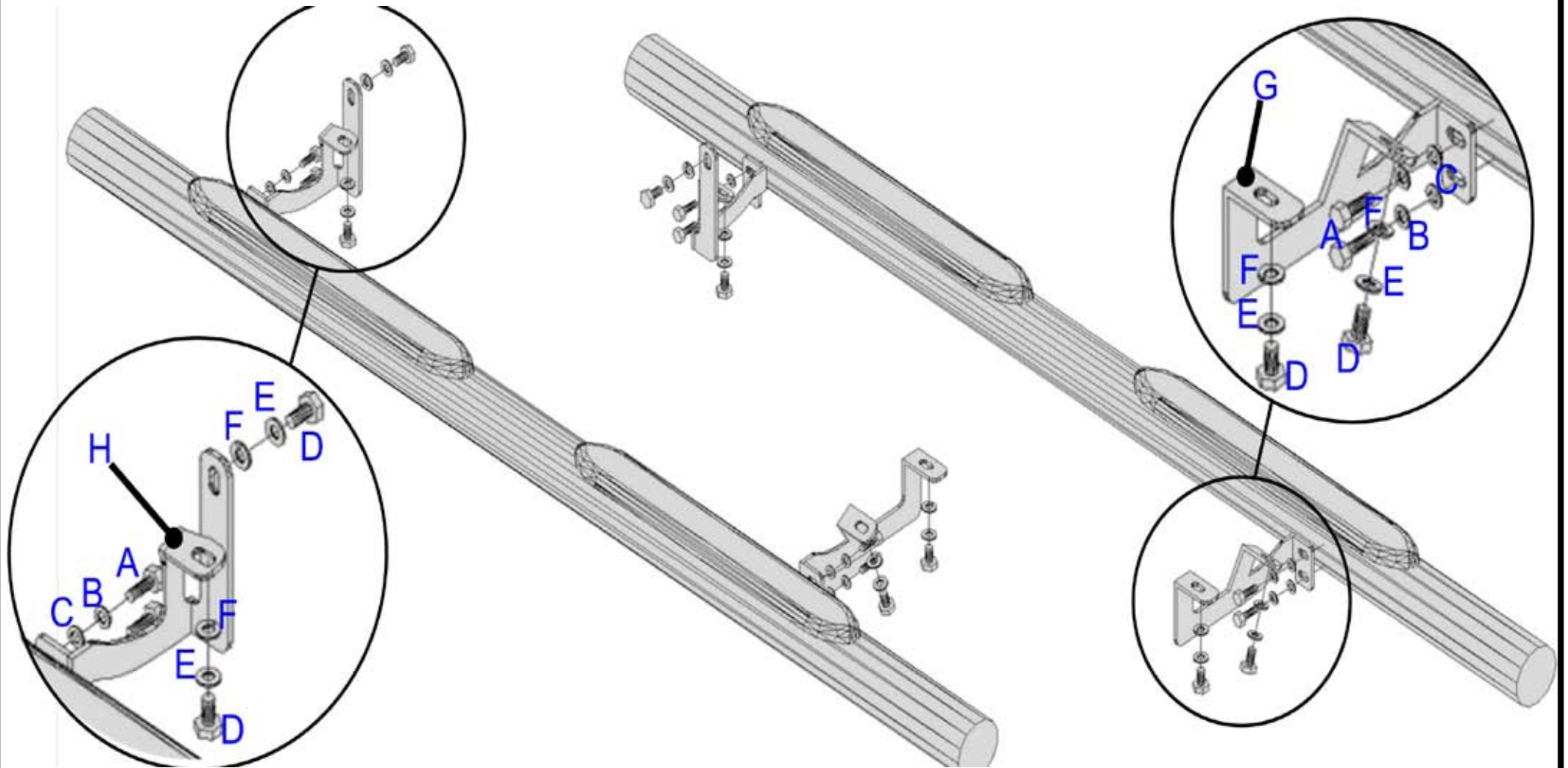

## FRONT SIDE

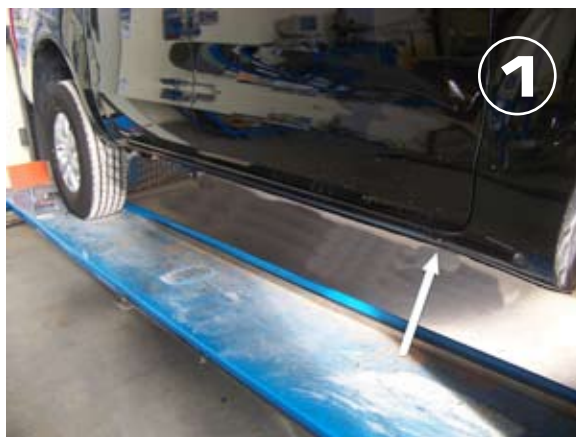

## PARTE ANTERIORE



## PARTIE ANTERIEURE



Date Data Date	Item Code Cod.Articolo Réf. Article	Vehicle model Modello Veicolo Modèle de Voiture
19/01/12	GP/295/IX	FORD RANGER D.C. 2012

 **MISUTONIDA**  
  **italian style accessories 4x4**

Document checked and approved by  
**Documento controllato ed approvato da**  
Document contrôlé et approuvé par

**Claudio  
Gallo**

# REAR SIDE

# PARTE POSTERIORE

# PARTIE POSTERIEURE

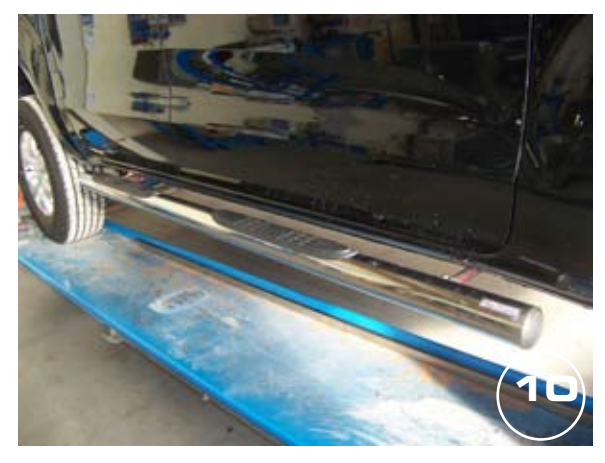

Date Data Date	Item Code Cod.Articolo Réf. Article	Vehicle model Modello Veicolo Modèle de Voiture
19/01/12	GP/295/IX	FORD RANGER D.C. 2012



Document checked and approved by  
**Documento controllato ed approvato da**  
 Document contrôlé et approuvé par

**Claudio  
 Gallo**