



Peugeot Expert / Toyota Proace / Citroen Jumpy 16-

Art. 826411

Põhjakaitse AdBlue paagile | Skid plate for AdBlue tank | Защита картера для бака AdBlue | Motorschutz für AdBlue tank



- | | |
|---|---|
| 1. Põhjakaitse / skid plate / защита картера / Motorschutz | 1 |
| 2. Kronstein / bracket / кронштейн / Konsole | 1 |
| 3. Kronstein / bracket / кронштейн / Konsole | 1 |
| 4. Kronstein / bracket / кронштейн / Konsole | 1 |
| 5. T-polt / T-bolt / T-болт / T-bolzen | 1 |
| 6. T-polt / T-bolt / T-болт / T-bolzen | 1 |
| 7. Polt / bolt / болт / Bolzen M8x25 | 3 |
| 8. Mutter / nut / гайка / Mutter M10 | 1 |
| 9. Mutter / nut / гайка / Mutter M8 | 3 |
| 10. Mutter / nut / гайка / Mutter M6 | 1 |
| 11. Seib / washer / шайба / Scheibe 10,5x20x2 | 1 |
| 12. Seib / washer / шайба / Scheibe 8,4x24x2 | 6 |
| 13. Seib / washer / шайба / Scheibe 6,4x12x1,6 | 1 |
| 14. Vedruseib / spring washer / пружинная шайба / Federnscheibe A10 | 1 |
| 15. Vedruseib / spring washer / пружинная шайба / Federnscheibe A8 | 1 |

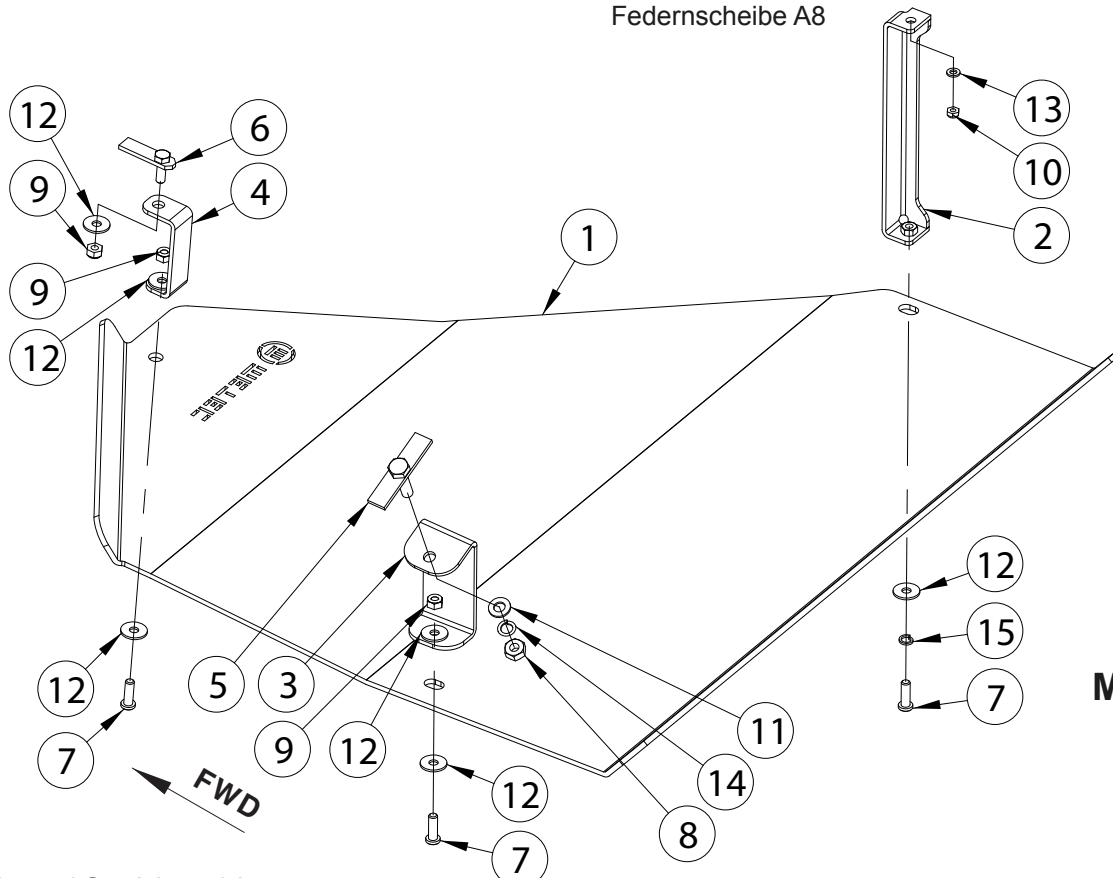

M6 - 11 Nm
M8 - 25 Nm
M10 - 50 Nm

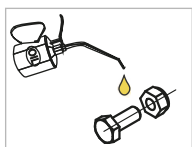

Kaal / Weight / Масса / Gewicht: 7,2 kg

Paigaldusaeg / Time of mounting / Время установки / Einbauzeit: 30min

Vajalikud tööriistad / Required Tools / Необходимые инструменты / Benötigte Werkzeuge



Peugeot Expert / Toyota Proace / Citroen Jumpy 16-

Põhjakaitse AdBlue paagile | Skid plate for AdBlue tank | Защита картера для бака AdBlue | Motorschutz für AdBlue tank

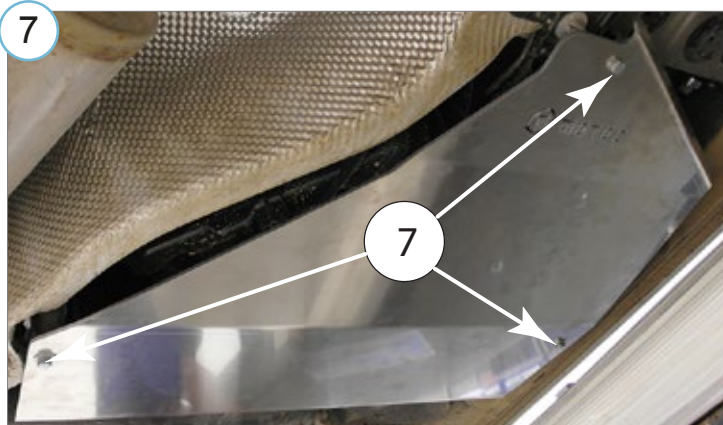
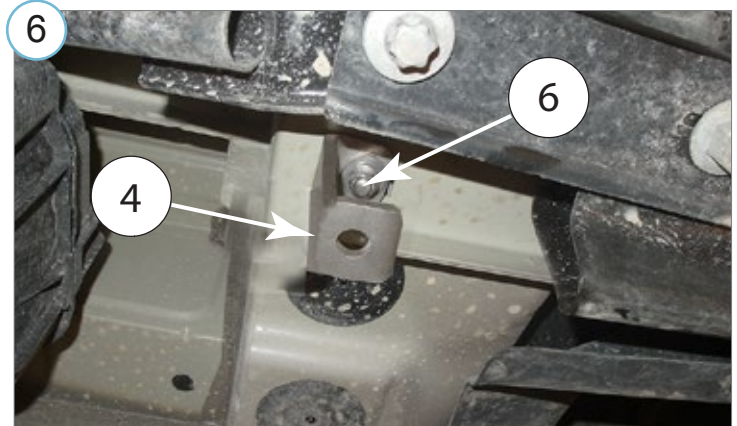
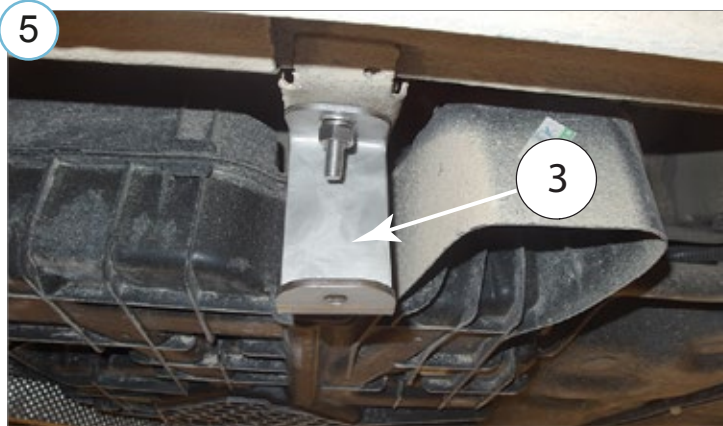
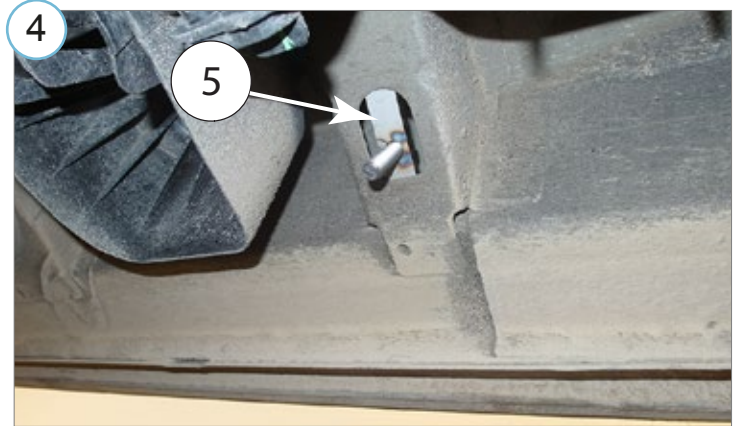
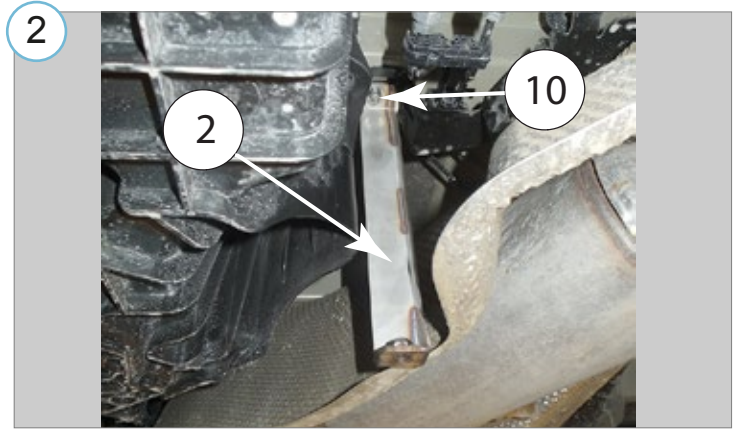
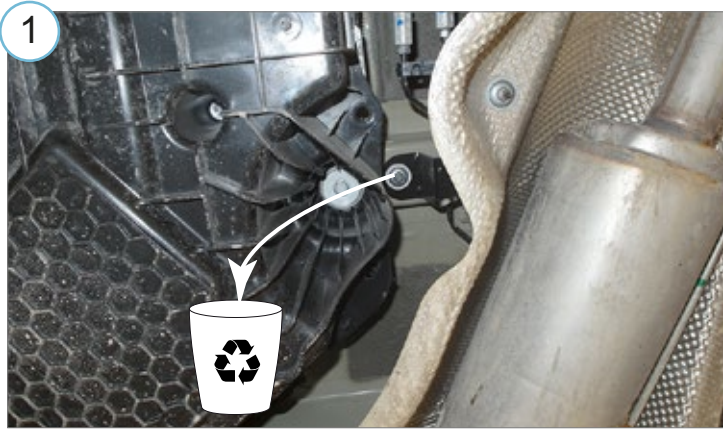

- Kui METEC toode ei vasta Teie ootustele või kui on tegemist toote ebapiisava kvaliteediga, siis pretensioonid esitada lehel www.metec.ee
- If the METEC product does not meet Your expectations or if it is a product of insufficient quality, then you can submit a claim at www.metec.ee
- Если METEC продукт не соответствует Вашим ожиданиям или это продукт недостаточного качества, то претензию предъявить можно на сайте www.metec.ee
- Wenn METEC Produkt nicht Ihren Erwartungen entspricht oder wenn es um Qualitätsmängel geht, dann bitte die Ansprüche auf Seite www.metec.ee einreichen