

MISUTONIDA
italian style accessories **4x4**

MITSUBISHI L200 D.C. 2015



GB

STAINLESS STEEL ROLL BAR MARK
ON TONNEAU 2 PIPES











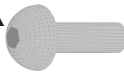

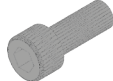
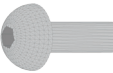
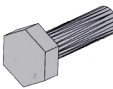
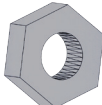
ITA

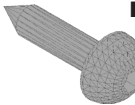
ROLL BAR MARK SPONDE IN
ACCIAIO INOX 2 TUBI

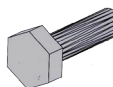
FR

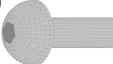
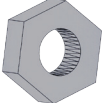
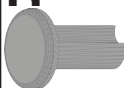
ROLL BAR MARK SUR LE BORD DE LA
BENNE EN ACCIER INOX 2 TUBES

Part List
 Lista della bulloneria
 Liste des pièces

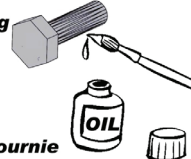
A  T B C E I M8X25 x 4	B  Ø 8 x 8	C  Ø 8 x 8	D  T C E I M10X25 x 4	E  T B C E I M8X30 x 4
F  TE M8X20 x 4	G  M8 x 4	H  VIPLA 09 Plastic Plastica Plastique x 4	I  PARKER M6X25 x 4	L  Plastic Ø 6 Plastica Plastique x 10
M  TE M6X20 x 4	N  Ø 6 x 12	O  Ø 6 x 12	P  T B C E I M6X20 x 8	Q  M6 x 8
R  Plastic Plastica Plastique x 6	S  MIT bracket Staffe MIT Etriers MIT x 4	T AS/9 x 2	U PS/9 x 2	V RLB/07 x 2
Z  RLS/9 x 2	W  RLS/9/B x 2	X  RLS/9/A x 2	<p><i>lubricate the set of bolts supplied before tightening them</i></p>  <p><i>Si consiglia di lubrificare la bulloneria in dotazione prima del settaggio</i></p> <p><i>Lubrifier la boulonnerie fournie avant de la serrer</i></p>	

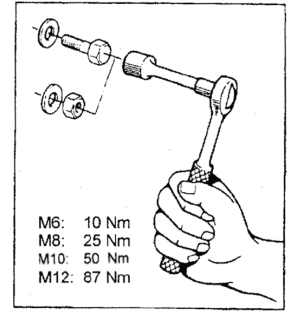
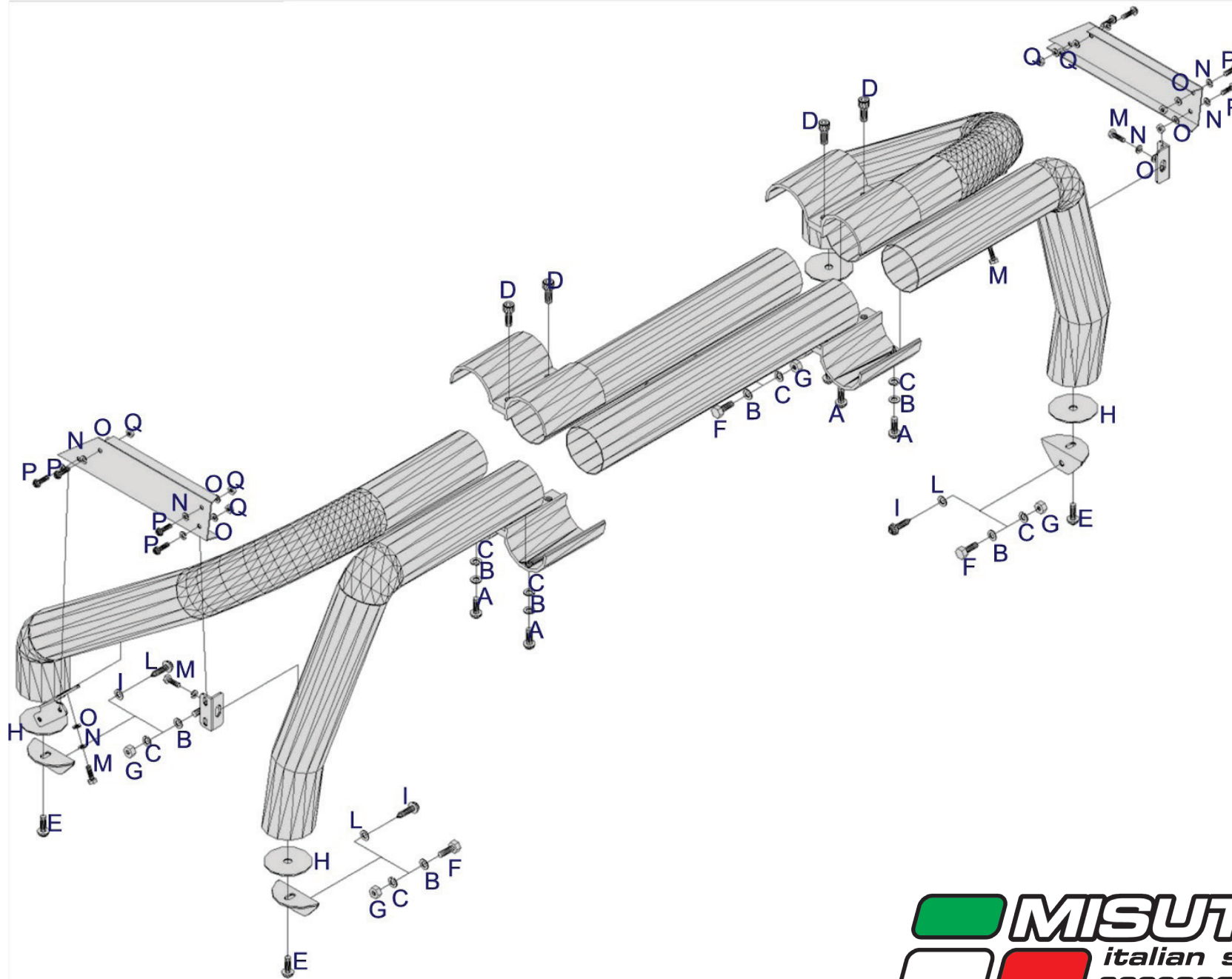

- M6: 10 Nm
- M8: 25 Nm
- M10: 50 Nm
- M12: 87 Nm

MISUTONIDA
 italian style accessories **4x4**

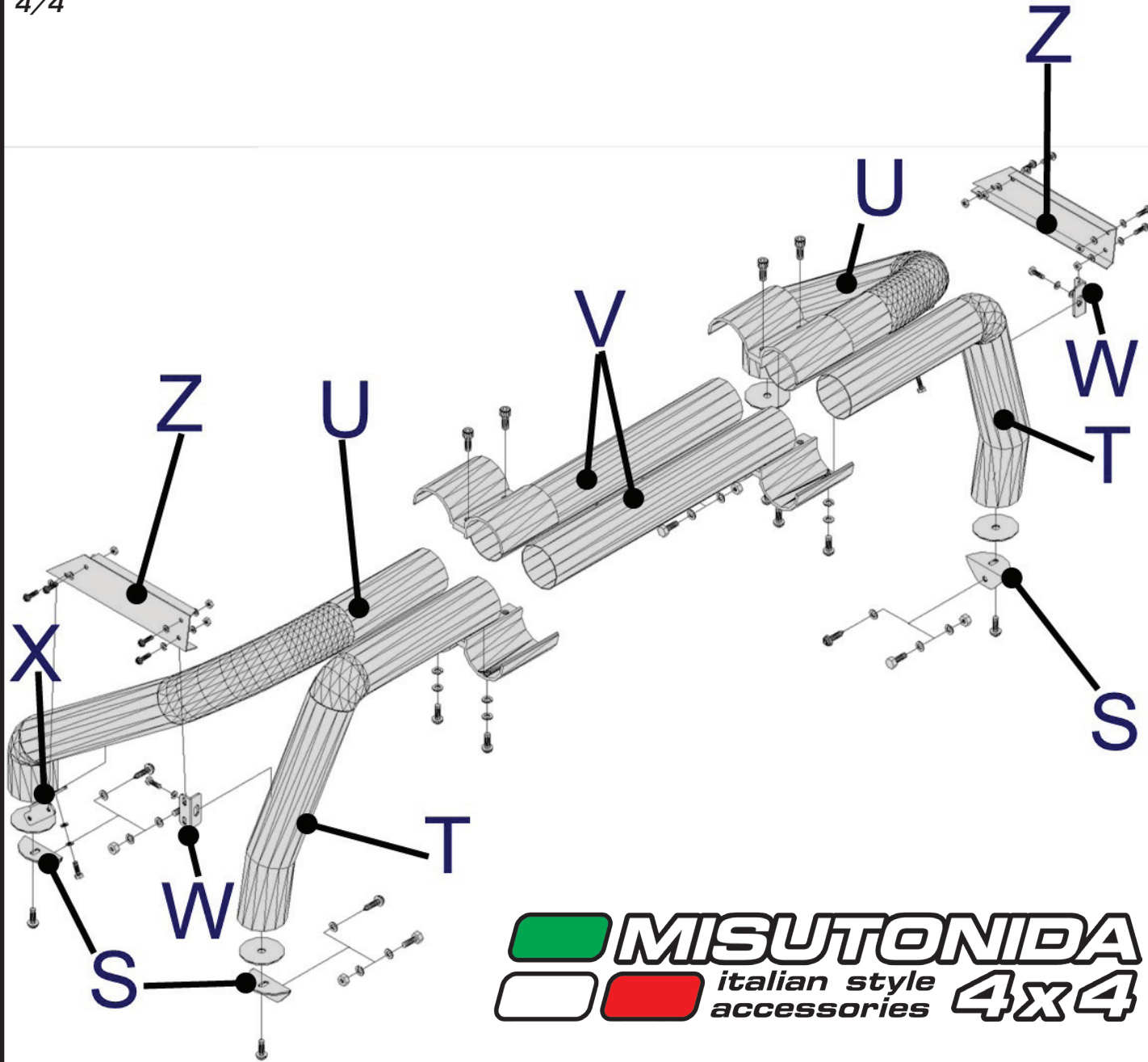

MISUTONIDA
italian style accessories **4x4**

